

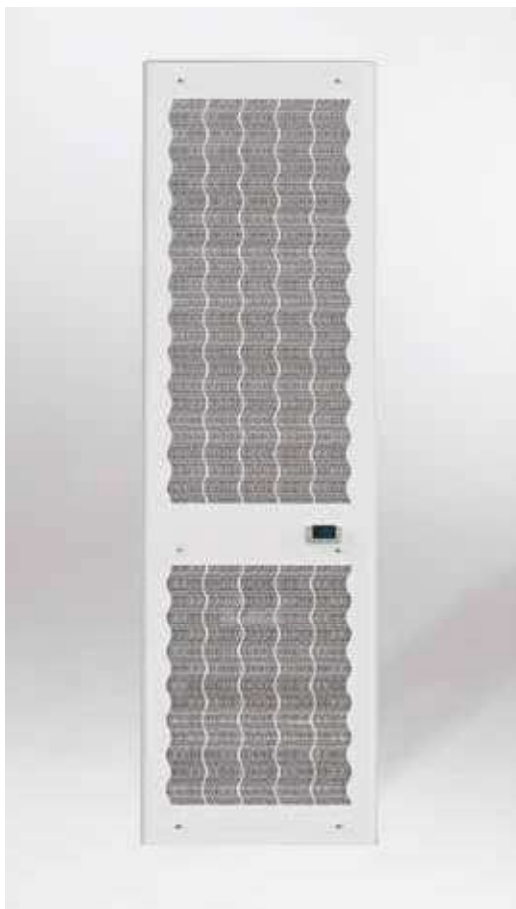

* Disponibile per alcuni modelli su richiesta con codice dedicato



CARATTERISTICHE GENERALI

- Elevata efficienza
- Capacità frigorifera: 500 - 4000 W
- Scheda elettronica XCB + display
- Installazione incasso totale, semi-incasso o esterna (optional)
- Connessioni elettriche rapide
- Connessione sequencing e Modbus
- Condensatore μ channel (da WIDS-14...)
- Dissipatore di condensa (da WIDS-14...)
- Contatti allarme generale e comando remoto
- Guarnizione già installata sul condizionatore
- Funzionamento fino ad una temperatura esterna di +60°C (optional)

OPTIONAL

- Colore speciale
- Pannello inox AISI304 o AISI316
- Versione low noise
- Relè sequenza fasi
- Trattamento protettivo sul condensatore
- Sonda remota

ACCESSORI

- Cornici Montaggio Semi-Incasso
- Cornici Montaggio Esterno
- Filtro aria
- Cavo di sequencing

OPTIONAL PER ACCESSORI

- Colore speciale
- Inox AISI304
- Inox AISI316

 **Gamma di condizionatori progettata per installazioni che necessitano di ingombri contenuti e ridotte sporgenze del quadro, con montaggio semplice e veloce.**

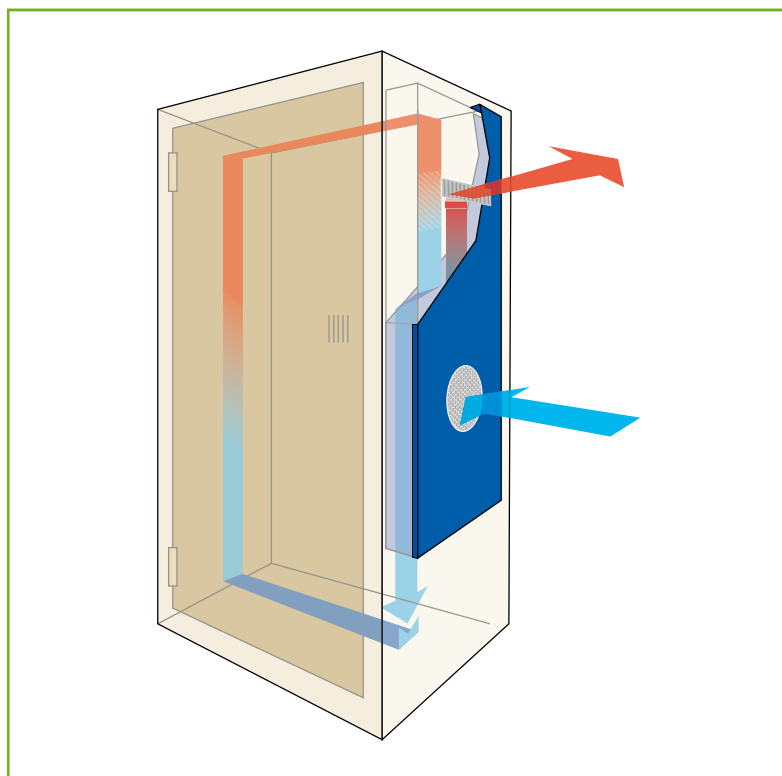

CONDIZIONATORI DA PORTA EXTRA-PIATTI

CODICE	CAPACITÀ DI RAFFREDDAMENTO	ALIMENTAZIONE	DIMENSIONI ESTERNE		
			LARGH.	ALT.	PROF.
WIDS	L35L35 DIN3168	V-ph-Hz			
WIDS-1023CW	1000 - 1050 W	230 - 1 - 50/60	375	956	196
WIDS-1423CW	1400 - 1500 W	230 - 1 - 50/60	454	1666	181
WIDS-2040CW	2100 - 2200 W	400 - 3 - 50 / 460 - 3 - 60	454	1666	181
WIDS-3040CW	3050 - 3200 W	400 - 3 - 50 / 460 - 3 - 60	496	1666	221

WIDS - 10

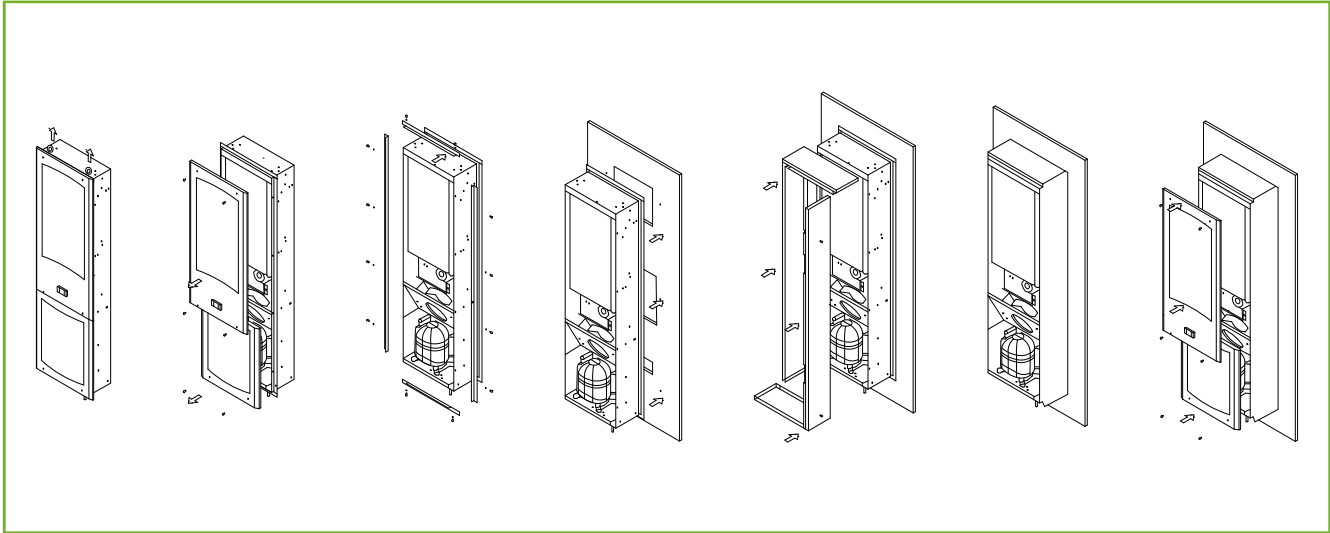

WIDS 14 - 20 - 30

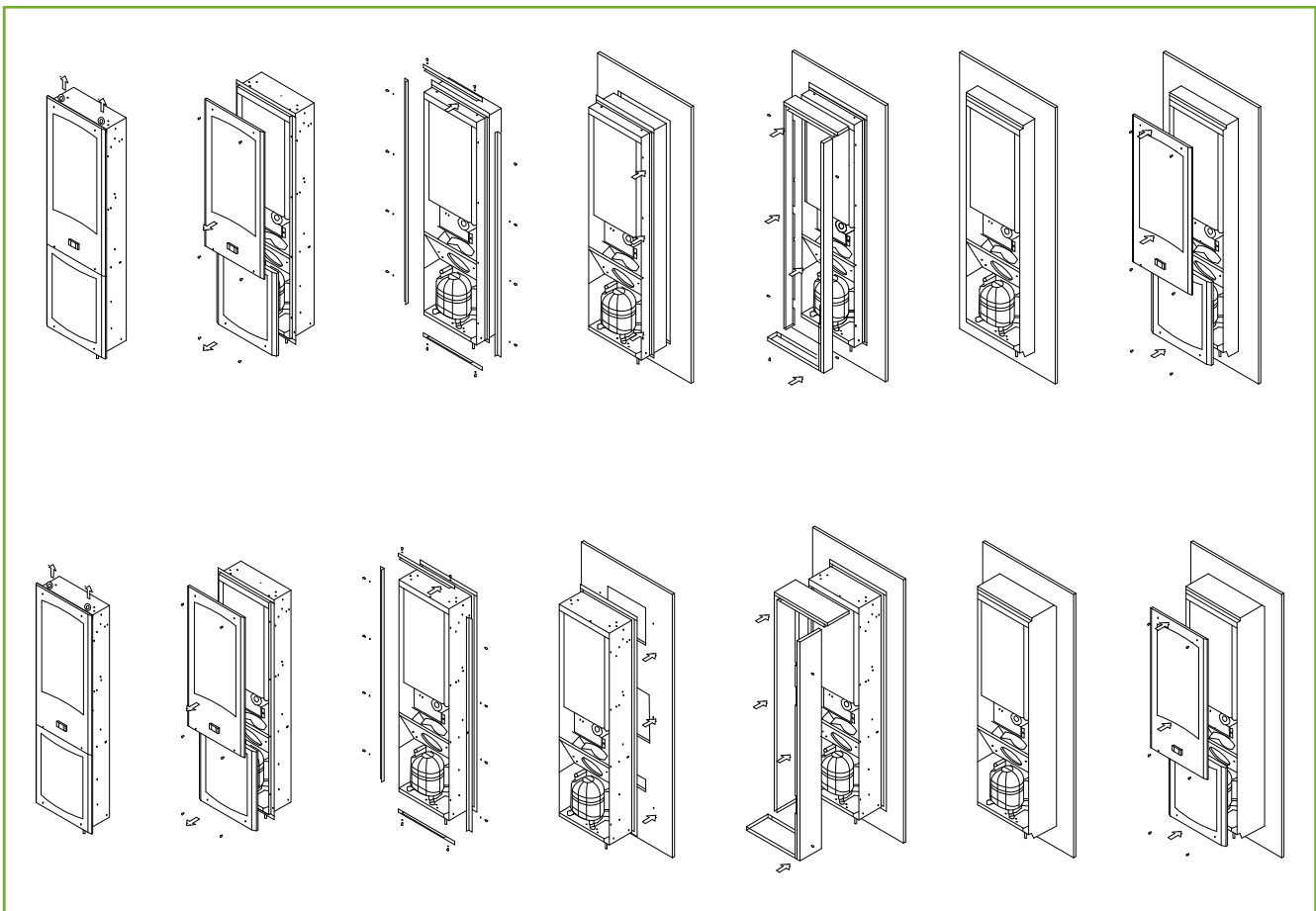

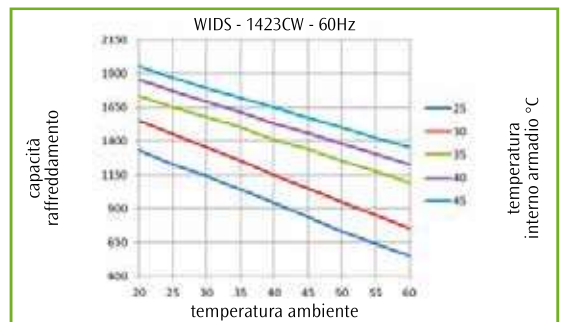
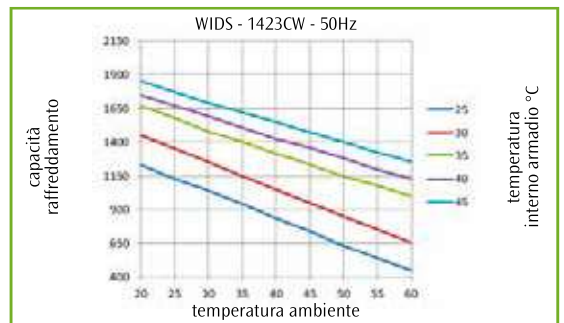
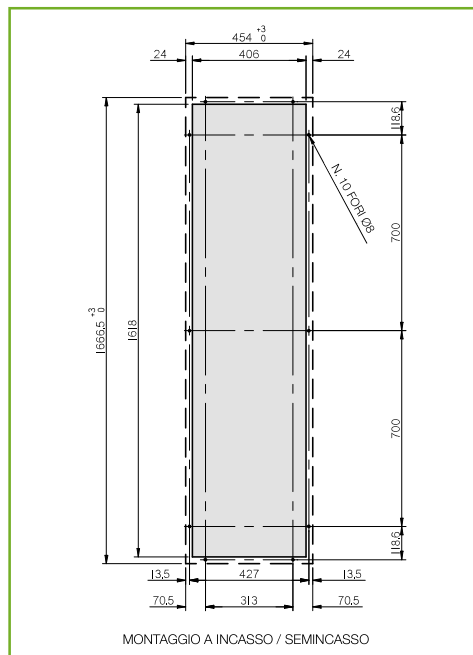
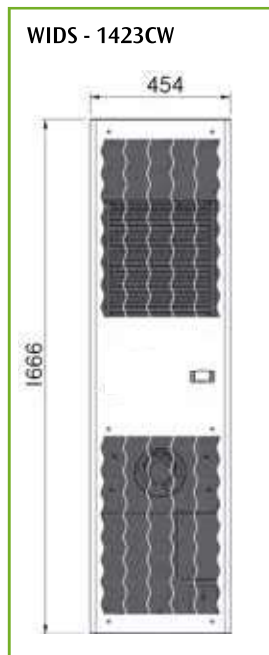
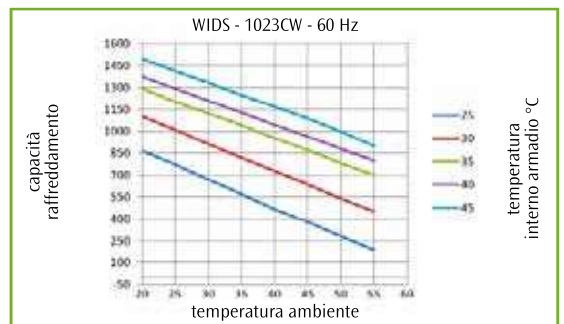
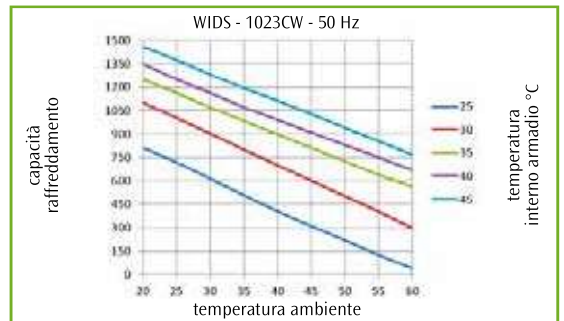
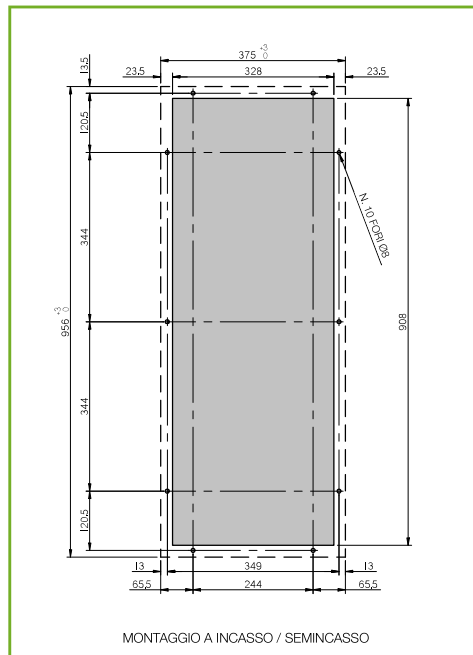
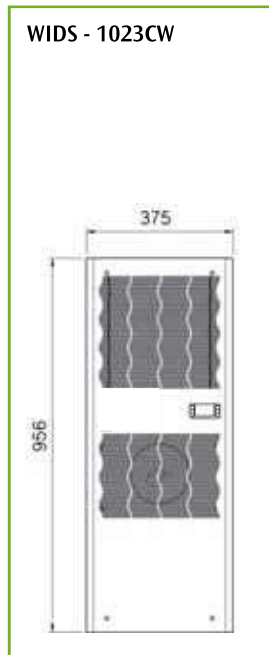

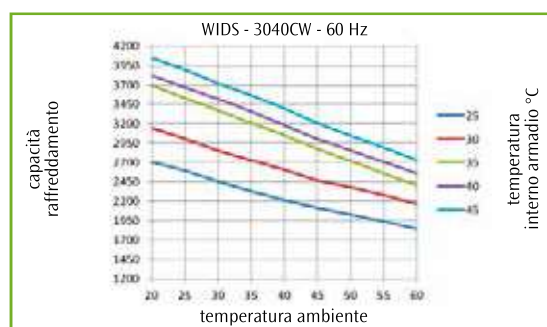
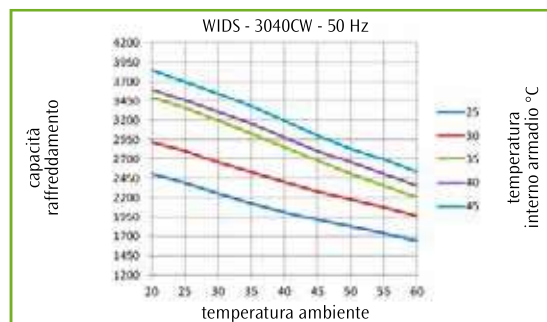
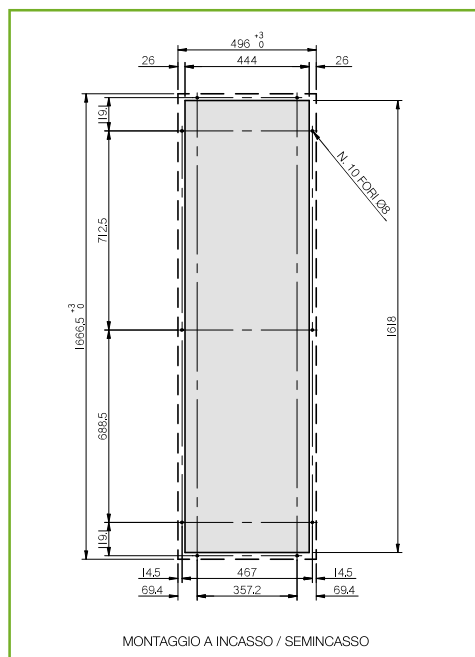
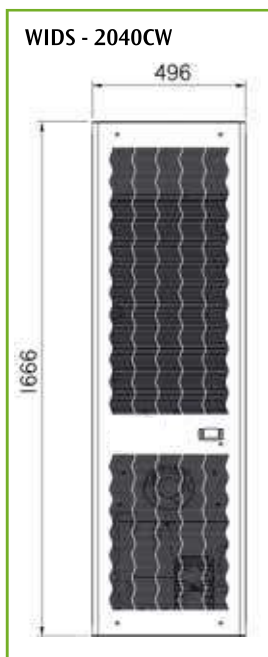
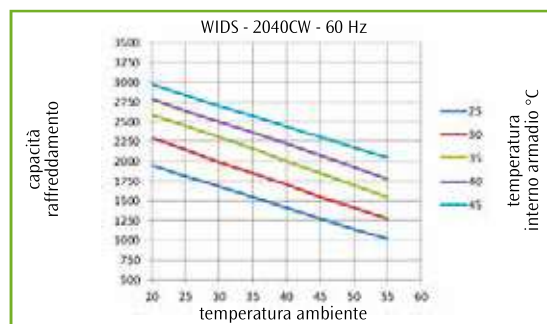
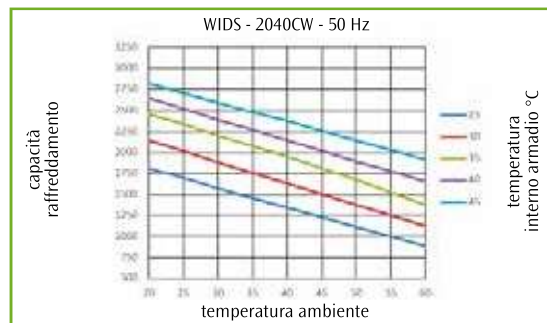
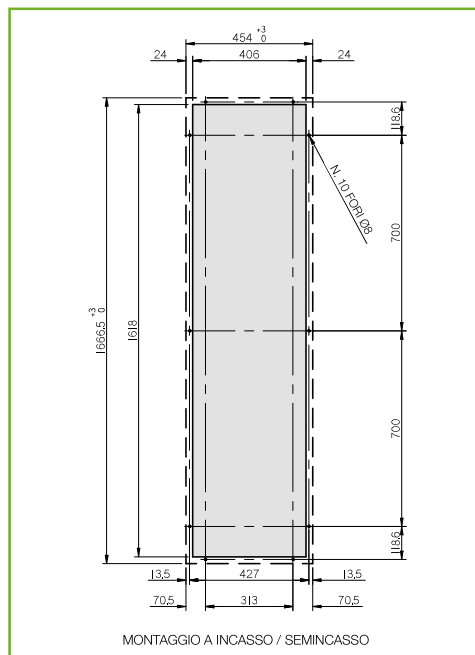
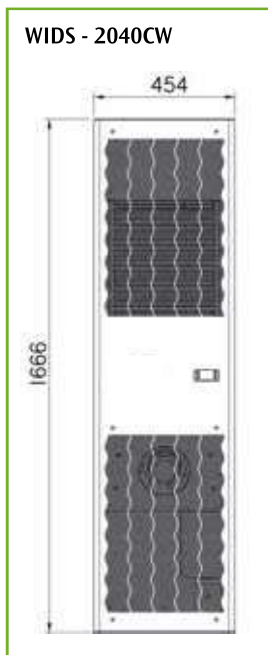

CONDIZIONATORI DA PORTA EXTRA-PIATTI

		WIDS-1023CW	WIDS-1423CW	WIDS-2040CW	WIDS-3040CW
TENSIONE NOMINALE	V.-	230	230	400,3	400,3
FREQUENZA NOMINALE	Hz	50 - 60	50 - 60	50	50
ALTEZZA	mm	956	1666	1666	1666
LARGHEZZA	mm	375	454	454	496
PROFONDITA'	mm	196	181	181	221
POTENZA FRIGORIFERA L35L35*	W	1000 - 1050	1400 - 1500	2100	3050
POTENZA FRIGORIFERA L35L50*	W	720 - 800	1150 - 1250	1675	2500
POTENZA ASSORBITA L35L35*	W	514 - 590	635 - 705	865	1085
POTENZA ASSORBITA L35L50*	W	595 - 710	730 - 820	1020	1300
TEMPERATURE INTERNE	°C	25 - 45	20 - 60	20 - 60	20 - 60
TEMPERATURE ESTERNE	°C	20 - 60 / 20 - 55	25 - 45	25 - 45	25 - 45
GRADI DI PROTEZIONE CIRCUITO INTERNO	IP/Type	54 / 12	54 / 12	54 / 12	54 / 12
PRESSIONE SONORA ESTERNA**	dB(A)	56	60	68	69

Dati unità con opzione heat pipe * DIN EN 14511 ** EN ISO 9614

Condizionamento